



DIANA

Owners's manual

INSTALATION, ADJUSTMENT AND OPERATING INSTRUCTION

Available in ceramic and metalsheet version.



CE

EN 13240

INTRODUCTION

Congratulations!

You have invested in energy efficient and high quality product - DIANA wood burning stove.
Your purchase will provide you years of clean and comfortable heating with minimal maintenance.

Please read this manual in its entirety. Its purpose is to familiarize you with your stove safe installation, operation and maintenance. It contains information that will be useful to you now and in years to come, so keep it handy and refer to it as needed.

Be sure to maintain the designated stovepipe and stove clearances to walls, ceilings, hearth, and other combustible surfaces. This will help reduce the risk of fire.

Failure to follow these instructions can result in property damage, bodily injury, and even death!

Locate your stove in a safe, convenient, open area; away from traffic flow, doors, and hallways; and near a chimney and chimney connector.

PURPOSE

DIANA wood burning stove is designed for heating.

TECHNICAL DATA

DIANA is produced in ceramic tiles and metal sheet tiles version.

Fire box dimensions (W x D x H)	(mm)	200 x 250 x 360
Nominal thermal output	(KW)	10
Appliance efficiency	%	89
Exhaust diameter	(mm)	Ø 120
Fuel type		wood, wood briquettes
Temperature of the gases	°C	108
Dust content of exhaust gases	mg/m ³	D=68
CO (13%O ₂)	%	0,0808
Net weight	(kg)	56,00
Brutto weight	(kg)	57,00

APPEARANCE AND PARTS

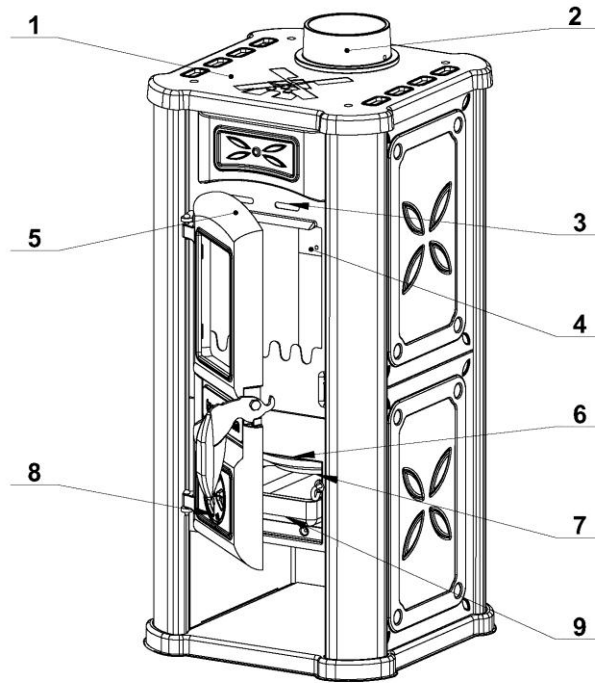

1. Top plate
2. Fume outlet
3. Secondary air
4. Tertiary air
5. Firebox doors
6. Grid carrier
7. Grid
8. Primary air regulator
9. Ash pan

DIMENSIONS

A	B	C	D	E	F
195mm	435mm	785mm	120mm	390mm	Ø 120mm

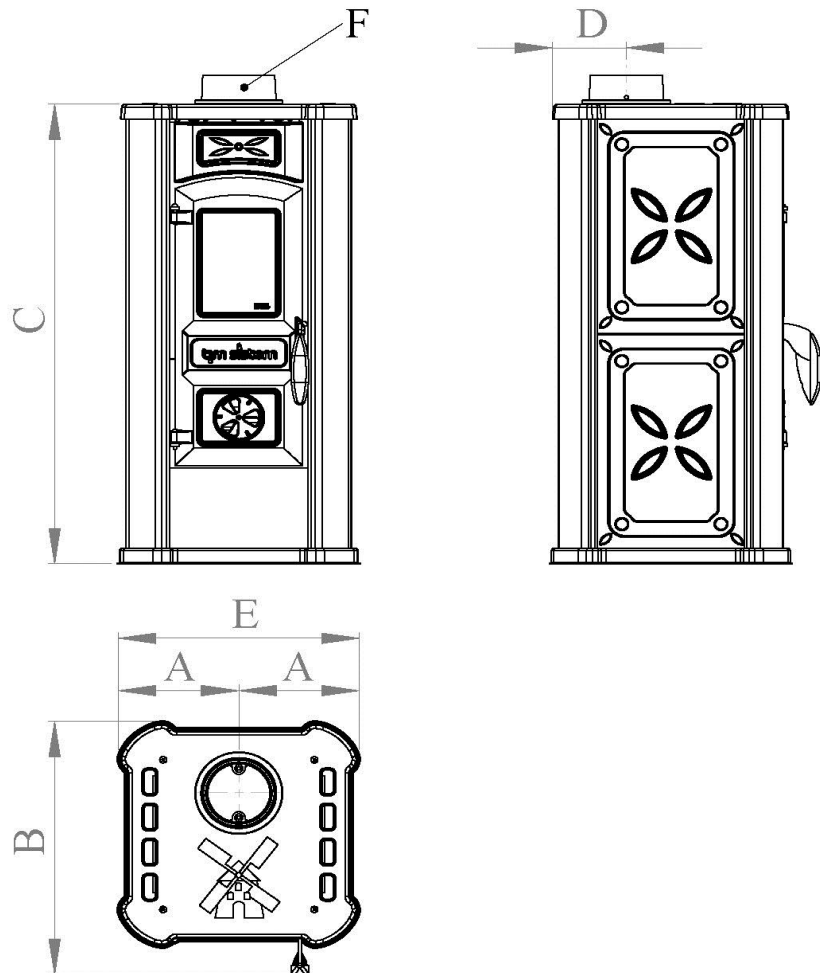
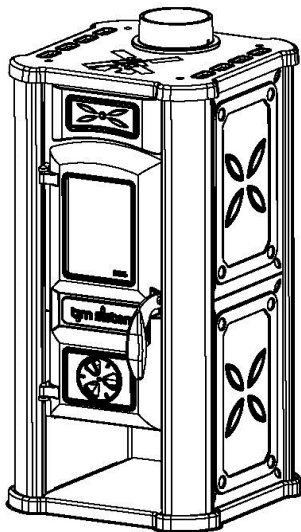

INSTALLING OF WOOD BURNING STOVE

Unpacking

TIM SISTEM is packing your stove with care so it could be safely transported. However, some damage can occur during transport.

When you receive your stove, unpack it carefully, inspecting your stove and all parts for damage. Make sure that all parts are included in the box. If any parts are damaged or missing, please contact your dealer immediately.

Installing

After choosing an appropriate spot, inspect this location to make sure that the stove will have enough clearance to combustible materials. These combustibles can include walls, floor, ceiling, cabinets, fireplace, and chimney. You must carefully consider the clearances to all of these combustibles before actually connecting your cook stove. When considering these clearances, also decide the kind of floor the stove will rest on. Depending on your floor, you can install your stove as it is, or use a floor protector, some types of flooring may require additional floor protection. A floor protector is any noncombustible surface laid on the floor underneath the stove that extends, 50cm beyond the fuel loading door and 10cm beyond each side of the cook stove

PRECAUTION MEASURES

Read and understand this Owner's Manual thoroughly before installing and using DIANA wood stove. Make sure to install your stove:

- According to the manufacturer's recommendations.
- In accordance with all applicable codes.
- With the proper sized chimney

When using your cooker:

- Warn children and others unfamiliar with wood-fired stoves about the danger of touching hot, radiating surfaces of your stove. For your additional safety, obtain hearth and stove guards through your local dealer.
- Keep pets away from the stove to prevent unnecessary hazards.
- Burn natural wood or briquettes only. Higher efficiencies and lower emissions result when burning air-dried, seasoned wood, as compared to green or freshly cut wood.
- Use caution when loading firewood into a hot stove.
- Keep the fuel loading door closed at all times except when loading wood.
- Keep the ash pan tray fully inserted.
- Avoid grease build-up when cooking on the top surface. Clean the surface regularly after using the cook top surface.
- **Never modify this stove in any way.**

- **Never burn kiln dried wood, painted or treated wood, solvents, trash, plywood, colored or glossy paper, artificial logs, cardboard, coal, garbage or driftwood.**
- **Epecially, do not burn coal in this stove**

CONNECTION TO CHIMNEY

After getting familiar with your stove and its part and before you connect it to a chimney, check the quality of the chimney. If the chimney is not highest quality we recommend that stove pipe sections should be attached to the cooker through fume exit on the top side. Attach the stove pipe to the stove's flue collar, with sheet metal screws.

- Exhaust pipes and connection to chimney must go up ways
- Horizontal parts of fume pipes should not be longer than 0,5m and they should always rise away from stove a minimum of 10° toward chimney.
- Fume pipes diameter should not get smaller.
- All connections must be tight, pipes and chimney must be clean and without any kind of dirt.
- Chimney must be protected from cold (insulated) especially in the case of metal chimney and in the case of exterior masonry chimney.
- Non vertical fume pipes which don't have insulation should not be longer than 1,25m

Chimney must fulfill the following conditions:

- Chimney goes above roof minimum 0,5m.
- Chimney should be higher than the first house next to it, higher than tree or any other obstacle.
- Interior chimney is preferable and exterior chimney must be well insulated.
- Chimney must be clean of any kind of dirt, bird nests or any kind of
- Stovepipe must not be attached too deep into chimney because it decreases fuming out.
- All unnecessary holes or cleaning doors on the chimney must be closed.

RIGHT

WRONG

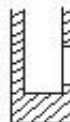
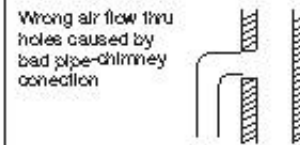
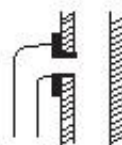
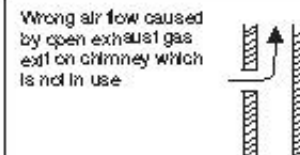
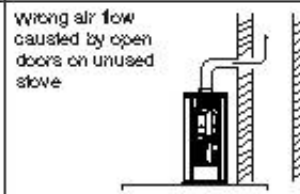
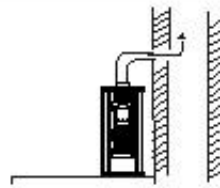
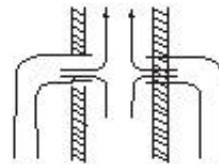
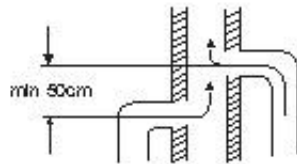
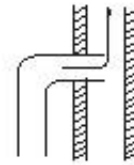
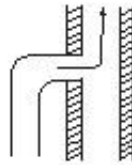
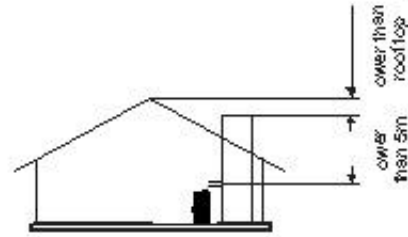
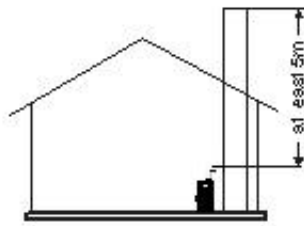
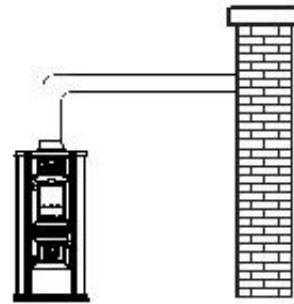
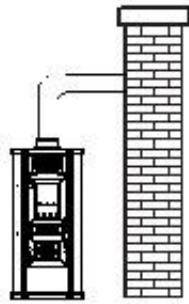

BUILDING A FIRE

Once you understand the controls of your wood stove and have chosen the appropriate firewood, you are ready to start a fire.

When you light your first fires, the wood stove will emit some smoke and fumes. This is normal "off-gassing" of the paints and oils used when manufacturing the wood stove. If you find it necessary, open a few windows to vent your room. The smoke and fumes will usually subside after 10 to 20 minutes of operation. The odor and smoke will end once the stove is "cured".

Starting fire

1. Open the door and place sheets of tightly twisted newspaper in the center of the firebox. Arrange kindling in a crisscross pattern over the newspaper. Kindling should be approximately ten pieces. Open the flue bypass system by pulling the handle out completely
2. Fully open the primary air control
3. Light the paper under the kindling
4. Close the door and allow the fire to burn.
5. Once the kindling is burning, open the door and add logs.
6. Put airflow control handle in starting position only in the case that you want to use oven. Otherwise, handle is always pulled out.
7. Once the fire is burning well, use the primary air control to regulate the desired rate of burn.

WARRANTY STATEMENT

Warranty is valid from the day of purchase which buyer can prove with verified and signed warranty protocol. Protocol include details about buyers address, date of purchase, signature and stamp of dealer or his service representative. Detailed warranty protocol must be made and verified by TIM SISTEM dealer.

Warranty will be acknowledged under following conditions:

- Product was handled according to instructions
- Product was not damaged
- Warranty protocol is verified by TIM SISTEM dealer or his representative

Name of product	Serial No.	Date of purchase	Signature and stamp of dealer or his service representative
DIANA			